

'TEKA

Effortless
Cooking

Kitchen
Appliances

Jun - Dec 2024
Collection





Limited Edition - White Kitchen Series

About Teka	4	Hoods	31
Limited Edition Series	6	Integrated Hoods & Hobs	36
Ovens	10	Integrated Dishwashers	40
Compacts	18	Refrigerators	42
Microwaves	22	Kitchen Sinks	43
Hobs	24	Kitchen Mixers	46

MÜ H LOS

'Muj:həʊs [adjective] / language: German

Mühelos - ohne Mühe oder Anstrengung; leicht zu erreichen oder zu tun.

Translation

Effortless - characterised by ease in achieving a desired outcome, particularly in home cooking. Synonymous with simplicity and efficiency.

Our Commitment

In Singapore, the bustling lifestyle often leads to the convenience of quick hawker meals. While these are tempting, we understand that many still recognise the value and health benefits of home cooking. Teka's advanced cooking technology simplifies this process, making it easier for you to enjoy the rewards of a home-cooked meal. We are dedicated to helping you foster a healthier, happier family life at every turn.

Why?

Because we understand the importance of nourishing meals for you and your family. And we are here to help transform busy schedules into healthy home menus.



Welcome to the World of Teka

Discover your ideal kitchen appliances with Teka, the brand trusted by homeowners across the world. Born in Germany, we embody quality, intuitive technology, and continuous innovation. Guided by a rich heritage, Teka assures that each product not only meets but upholds the highest standards, ensuring you receive exceptional value at a fair price.

From a single factory in Germany, Teka has expanded to have a global presence, underscoring our position as a leader in kitchen appliances.

15

Factories in Europe, America & Asia

120+

Countries served

100,000,000

Customers worldwide and still growing

+1

Awaiting you. Join our global family of satisfied customers

TEKA | 100 YEARS

Celebrating over 100 years of excellence, our unwavering commitment to delivering the best products, characterized by quality, innovation, and design, has earned us global recognition with 52 prestigious awards in recent years.

Your trust and support have been instrumental in this journey, making our achievements not just ours, but yours as well.



TEKA

Infinity | G1
Collection



Limited Edition



INFINITY | G1

In the fusion of Teka's precise engineering and Italdesign Giugiaro's visionary aesthetics, the Infinity | G1 Collection emerges - not just as a series, but as a manifesto of luxury design transcendence.

In every detail, the Infinity Design embodies the philosophy that exceptional design is an odyssey, not a privilege. It is where the everyday kitchen ritual transforms into a choreography of ingenuity and finesse, crafting experiences that linger beyond taste and time.



“Our inspiration was drawn from the elegant contours of automobiles, sculptural, aerodynamic, and infused with futuristic lines that bestow a distinguished and unique character to the overall design.”

Nicola Guelfo,
Head of Industrial Design,
Italdesign Giugiaro

Italdesign Giugiaro stands at the forefront of automotive design, renowned for pioneering solutions in iconic supercar brands such as Lamborghini, Ferrari, and Maserati.

HLB 85-G1
60cm Built-in Oven

71 litres

Dimensions: W x H x D (mm)
595 x 595 x 559

15 Amp

Product Highlights:

- Exclusive matte black finishing with premium copper touches
- Automatic Pizza Grill (340°C)
- Special stone for pizza cooking
- SurroundTemp even heat distribution
- DualClean: Pyrolysis & HydroClean® Pro
- 4 glazed door + SoftClose

Cooking Functions: 8

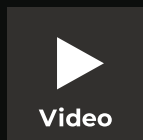

\$3,900



ML 82-G1

Built-in Microwave + Grill

22
litres

Dimensions: W x H x D (mm)

595 x 390 x 334

Product Highlights:

- Exclusive matte black finishing with premium copper touches
- 5 power levels: 850W
- Grill power: 1200W
- Quick start
- Ceramic base for uniform heating
- Double glazed door with left opening

Cooking Functions & Features: 6



\$2,800



IBF 64-G1

60cm Induction Hob

4
zones

Dimensions: W x H x D (mm)

600 x 510 x 53

15-30
Amp

Product Highlights:

- Exclusive matte black finishing with premium copper touches
- 4 cooking zones (mm): Ø 235 x 188.5
- FlexiZone - combine cooking zones to adapt all cookware sizes
- Intelligent temperature sensors
- Intuitive Multislider touch control

DirectSense Cooking Functions: 3



\$3,300



DVI 88-G1

80cm Decorative Vertical Hood

730
m³/h

Dimensions: W x H x D (mm)

800 x 800 - 1100 x 435

Product Highlights:

- Exclusive matte black finishing with premium copper touches
- FreshAir function
- 3 speeds + intensive
- Rim extraction
- Brushless EcoPower motor
- Push buttons control
- Stop delay timer
- 3-layered aluminium filter
- Filter saturation indicator

\$2,900

Ovens Advantage

In the heart of European culinary tradition, the oven is a cornerstone, a symbol of home and hearth where flavours are crafted and memories baked. Teka, with its roots deep in this rich heritage, brings a century of refined expertise to your kitchen. Our ovens are designed not just to meet, but to anticipate your needs.

Expertly engineered for the discerning chef, each Teka oven is a culmination of detailed understanding gleaned from generations of service. With intuitive features centred around your convenience, we ensure a refreshingly familiar experience. And with our signature specialty ovens, we invite you to elevate your dishes to new gourmet heights with the utmost ease.

Trusted across generations, discover all the possibilities in simplifying cooking complexities and bringing the joy of effortless cooking into your home.

Highlights



SurroundTemp

The secret to even cooking

Discover the simplicity of uniform cooking with SurroundTemp. Our exclusive heating system circulates hot air evenly, ensuring optimal results every time you cook.



HydroClean® Pro

The power of steam

Teka oven's proprietary self-cleaning technology harnesses the power of steam to soften even the toughest stains, reducing your effort and giving you back precious family time.

Pyrolytic cleaning

Spotless at high heat

Engage the pyrolytic cleaning function to effectively incinerate food residue into ash. An easy quick wipe is all that's needed afterwards, simplifying your oven's routine maintenance.



Safety first

Designed with you in mind

Your safety informs our design. Enjoy the convenience of telescopic guides for safe and easy access. Benefit from SoftClose doors that shut smoothly, without spills or injuries.

And with built-in child safety locks, rest assured that curious little hands are kept out of harm's way. With Teka ovens, enjoy cooking with absolute confidence and peace of mind.



Ovens - Signature Series



SteakMaster

60cm Built-in Steam Oven

Transform your home kitchen into a steakhouse with the SteakMaster, co-designed with Michelin chefs to effortlessly deliver restaurant-quality steaks. Featuring the exclusive SteakGrill, which soars to an intense 700°C, you can achieve juicy perfection quickly and affordably, right at the comfort of your home.

Dimensions: W x H x D (mm)

595 x 595 x 559

Cooking Functions: 12

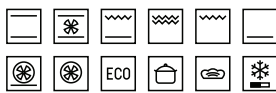

Product Highlights:

- Exclusive SteakGrill (700°C)
- Special cast iron grill for steaks
- 20 automatic programs for meat
- DualClean: Pyrolysis & HydroClean® Pro
- 4 glazed door + SoftClose



\$4,290 Usual Price \$5,300



Ovens - Signature Series



SteamGourmet HLB 8550 SC

60cm Built-in Steam Oven

Experience irresistibly healthy flavours with SteamGourmet, a professional-grade masterpiece for home chefs. From sous vide finesse to the perfect balance of heat and steam, achieve refined taste with our three specialised steam functions.

Dimensions: W x H x D (mm)

595 x 595 x 559

Cooking Functions: 12



71 litres
15 Amp

Product Highlights:

- 3 specialised steam functions
- Easy & safe telescopic tray guides
- SurroundTemp even heat distribution
- HydroClean® Pro self-cleaning
- 3 glazed door + SoftClose



\$4,090 Usual Price \$5,200



Ovens - Signature Series



MaestroPizza HLB 8510 P

60cm Built-in Oven

Bring home the pizzeria experience with Teka's MaestroPizza oven. Fire up the authentic taste with our exclusive 340°C to ensure a chef quality crunch every time.

Dimensions: W x H x D (mm)

595 x 595 x 559

Cooking Functions: 8



71 litres

15 Amp

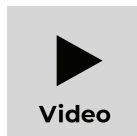

Video

Product Highlights:

- Exclusive Pizza Grill (340°C)
- Professional cordierite pizza stone included
- SurroundTemp even heat distribution
- DualClean: Pyrolysis & HydroClean® Pro
- 4 glazed door + SoftClose

\$3,090 Usual Price \$4,200



AirFry HLB 8416

60cm Built-in Oven

Get ready for delicious, oil-free indulgence with Teka's AirFry oven. Transform even vegetables into juicy, crunchy treats. Relish in guilt-free pleasure with every bite!

Dimensions: W x H x D (mm)

595 x 595 x 559

Cooking Functions: 10



71 litres

13 Amp



Video

Product Highlights:

- Exclusive AirFry function
- FryMaster box for flip-free even cooking
- SurroundTemp even heat distribution
- HydroClean® Pro self-cleaning
- 3 glazed door + SoftClose

\$2,490 Usual Price \$3,300



Ovens - Signature Series



SteamBox

Oven Accessory

Full steam ahead into wellness with SteamBox, a game-changing accessory that unlocks your Teka oven's steam capabilities, expanding your culinary repertoire with nutritious and flavour-rich dishes.

Dimensions: W x H x D (mm)

460 x 100 x 380

Simply add water to the deep tray, slide it into your oven, and witness the vibrant preservation of food essence.

Product Highlights:

Turn your oven into a pro steamer

2 individual trays, 1 extra deep tray

Glass lid & inner grid

Suitable for SteakMaster,
HSB, HLB and HCB ovens



\$390 Usual Price \$490

Understanding your Teka oven

Mastering the use of your Teka oven begins with understanding its symbols and functions. Our clear and concise guide helps you easily understand your oven's capabilities, ensuring you can effortlessly achieve delicious results every time.



Conventional Heating

Even heat distribution for consistent baking, ideal for recipes like sponge cakes.



Grill + Bottom

Combines grill and bottom heat, perfect for evenly roasted meats.



Conventional + Fan

Blends traditional heating with fan circulation, good for evenly cooked roasts and cakes.



Bottom

Heat focused from the bottom, excellent for crispy bases in pastry dishes.



Grill

Direct, intense heat from above, great for grilling and browning meats.



Grill + Fan

Top grilling with fan-assisted heat, ensuring even browning.



MaxiGrill

Efficiently grills larger surfaces, suitable for big dishes.



MaxiGrill + Fan

Suitable for both surfaces roasting and even cooking of meats and casseroles.



Turbo

Consistent temperature for multi-level cooking, ideal for cooking multiple dishes.



Pizza

Tailored for pizzas and pastries, ensuring crispy crusts and evenly cooked toppings.



MaestroPizza 340°C

Reaches high temperatures for authentic stone-fired pizza taste.



Eco

Efficient, energy-saving cooking with intelligent temperature control.



Defrosting

Thaws food quickly and evenly, preparing it for cooking.



Slow Cooking

Lowers cooking speed for tender, flavourful dishes.



Ferment / Proofing / Rising

Steady low temperature of 30°C to 40°C, optimal for dough proofing.



Full Steam / Sous Vide

Sous vide cooking. Low, steady heat for prolonged periods, preserving food's appearance and nutrients.



Conventional + Steam

Fuses dry heat and steam for crispy exteriors and juicy interiors.



Regeneration

Gently reheats with steam, retaining food's moisture and taste.



Turbo + Steam

Combines high-speed air circulation with steam for quick, moist cooking.



Microwave

Basic function for quick heating and cooking.



Microwave + Grill

Combines microwave speed with grilling for fast, crispy results.



Fast Preheating

Quickly brings the oven up to the desired temperature for efficient cooking.



HydroClean® Pro

Turns water to steam to soften stubborn grease for easy cleaning.



Pyrolysis

High-temperature cleaning that turns residues into ash for easy wipe-down.



HLB 860 P
60cm Built-in Oven

71 litres

Dimensions: W x H x D (mm)
595 x 595 x 559

15 Amp

Product Highlights:

- Personal cooking assistant: 20 recipes
- Easy & safe telescopic tray guides
- SurroundTemp even heat distribution
- DualClean: Pyrolysis & HydroClean® Pro
- 4 glazed door + SoftClose

Cooking Functions & Features: 12



\$3,490 Usual Price \$4,300



HLB 850
60cm Built-in Oven

71 litres

Dimensions: W x H x D (mm)
595 x 595 x 559

13 Amp

Product Highlights:

- A+ energy saving (up to 20%)
- Easy & safe telescopic tray guides
- SurroundTemp even heat distribution
- HydroClean® Pro self-cleaning
- 3 glazed door + SoftClose

Cooking Functions & Features: 9



\$1,990 Usual Price \$2,200

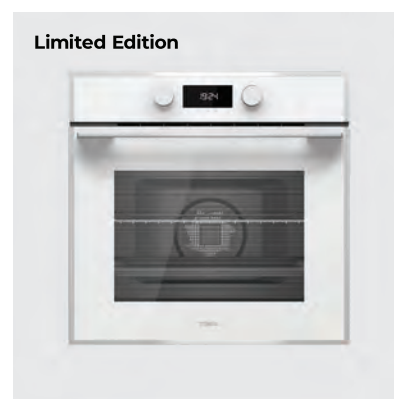

HLB 840 White
60cm Built-in Oven

71 litres

Dimensions: W x H x D (mm)
595 x 595 x 559

13 Amp

Product Highlights:

- A+ energy saving (up to 20%)
- Easy & safe telescopic tray guides
- Express pre-heating
- SurroundTemp even heat distribution
- HydroClean® Pro self-cleaning

Cooking Functions & Features: 9



\$1,890 Usual Price \$2,200



HSB 645
60cm Built-in Oven

71
litres

Dimensions: W x H x D (mm)
595 x 595 x 559

13
Amp

Product Highlights:

- A+ energy saving (up to 20%)
- Easy & safe telescopic tray guides
- Express pre-heating
- SurroundTemp even heat distribution
- HydroClean® Pro self-cleaning

Cooking Functions & Features: 9

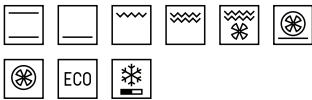

\$1,590 Usual Price \$1,900



HCB 6435
60cm Built-in Oven

65
litres

Dimensions: W x H x D (mm)
595 x 595 x 559

13
Amp

Product Highlights:

- A+ energy saving (up to 20%)
- Express pre-heating
- Children safety lock
- HydroClean® Pro self-cleaning

Cooking Functions & Features: 8

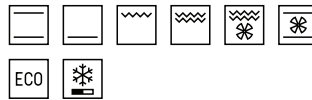

\$1,290 Usual Price \$1,450



HLF 940
90cm Built-in Oven

77
litres

Dimensions: W x H x D (mm)
890 x 480 x 538

13
Amp

Product Highlights:

- XXXL capacity: 77 litres
- Easy & safe telescopic tray guides
- Double lateral light
- HydroClean® Pro self-cleaning
- 3 glazed door

Cooking Functions & Features: 9

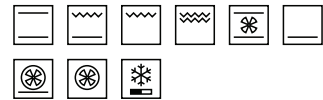

\$3,990 Usual Price \$4,300

Compacts Advantage

In the realm of confined spaces, Teka Compacts stand as a testament to ingenious design, masterfully encapsulating both style and performance. Each piece is akin to a meticulously crafted masterpiece, where every detail is a deliberate stroke of genius, echoing the precision of artistic mastery.

Here, form and function converge in a symphony, creating a canvas where personal culinary style is the protagonist. Each Teka Compact is more than an appliance; it's an invitation to redefine your interaction with the kitchen space.

Refined by
Simplicity

Defined by
Sophistication



HLC 847 C
45cm
Microwave
Oven Combi

HLC 847 SC
45cm
Steam
Oven Combi

CLC 855 GM
45cm
Built-in
Coffee Machine

CP-15 GS
45cm
Telescopic
Plate Warmer





HLC 847 SC

45cm Steam Oven Combi

45 litres

Dimensions: W x H x D (mm)

595 x 455 x 559

13 Amp

Product Highlights:

- Multifunctional oven + Steamer
- Steam cooking: 30°C - 100°C
- Cooking assistant: 20 recipes
- Slow cook, sterilization & regeneration function
- Children safety lock
- Meatprobe included
- SurroundTemp even heat distribution
- HydroClean® Pro self-cleaning
- 4 glazed door + SoftClose

Cooking Functions & Features: 15

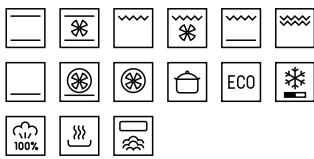

\$3,990

Usual Price \$4,700



HLC 847 C

45cm Microwave Oven Combi

41 litres

Dimensions: W x H x D (mm)

595 x 455 x 559

13 Amp

Product Highlights:

- Multifunctional oven + Microwave
- 5 power levels + 1000W microwave
- Cooking assistant: 20 recipes
- Defrost by weight and time
- Touch control display with electronic timer
- Children safety lock
- SurroundTemp even heat distribution
- HydroClean® Pro self-cleaning
- 3 glazed door + SoftClose

Cooking Functions & Features: 15

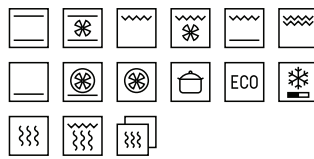

\$3,390

Usual Price \$3,900



CP-15 GS

Telescopic Plate Warmer

6 servings

Dimensions: W x H x D (mm)

595 x 140 x 557

Product Highlights:

- Glass front with fingerprint proof stainless steel
- Detachable telescopic drawer
- Adjustable thermostat: 30°C - 80°C

\$1,590



CLC 855 GM
45cm Built-in Coffee Machine

1.8 litres

Dimensions: W x H x D (mm)
595 x 455 x 412

Product Highlights:

- 30 automatic programs
- 3 functions; coffee, steam & hot water
- Integrated steel grinder for natural coffee beans
- Availability for ground coffee
- Capacity: 2 cups at a time

- Self-cleaning function
- Adjustable height system for different cup sizes
- 1.8 litres water tank
- 15 bar pump pressure

\$4,950



CLC 835 MC
45cm Built-in Coffee Machine

1 litre

Dimensions: W x H x D (mm)
595 x 455 x 330

Product Highlights:

- Multiple capsule and ground built-in coffee machine
- 5 capsules adaptors: Nespresso®, Lavazza, Caffitaly, E.S.E pod
- Retractable pipe for milk frother, steam and hot water
- Adjustable height system for different cup sizes

- Descaling function
- Electronic control with TFT display
- Capacity: 1 cup
- Temperature selector
- 1 storage drawer + 2 side storage compartments
- 19 bar pump pressure

\$3,850 Usual Price \$4,300



Share heartfelt moments over cups of exquisite espresso or cappuccino made with our Teka compact coffee machine. It enhances the aromas and flavours of your favourite blends, inviting great conversations. Choose between a built-in capsule model or a coffee grinder model—both designed to deliver hot, aromatic coffee just the way you like it.





Delivering the
Essence of Convenience
for modern
Singapore living

Microwaves Advantage

In bustling Singapore, where speed and efficiency are essential, Teka built-in Microwaves stand out as the epitome of kitchen convenience. These versatile microwaves excel beyond quick reheating, featuring a grill function for an expanded range of cooking options. Ideal for everything from swift snacks to delicious grilled dishes, they are designed to meet the needs of a fast-paced modern lifestyle.

For sleek integration, Teka Microwaves present a polished, flush look in both stainless steel and black glass finishes.



ML 825 TFL

Built-in Microwave + Grill

25 litres

Dimensions: W x H x D (mm)
595 x 390 x 390

Product Highlights:

- Touch Control panel and TFT display
- 5 power levels: 900W
- Quick start + 30 secs
- 2 stage cooking programming
- 8 auto direct access menus
- 31.5cm turntable
- Child safety block
- Black glass with stainless steel frame

Cooking Functions & Features: 6



\$1,190

Usual Price \$1,550

MWE 259 FI

Built-in Microwave + Grill

25 litres

Dimensions: W x H x D (mm)
595 x 388 x 385

Product Highlights:

- Full Electronic control panel with LED display
- 5 power levels: 900W
- Quick start + 30 secs
- 8 auto direct access menus
- 31.5cm turntable
- Child safety block
- Full black glass

Cooking Functions & Features: 6



\$950

Usual Price \$1,100

MWE 209 FI

Built-in Microwave + Grill

20 litres

Dimensions: W x H x D (mm)
595 x 382 x 362

Product Highlights:

- Electronic control panel
- 5 power levels: 800W
- Quick start + 30 secs
- 8 auto direct access menus
- 24.5cm turntable
- Child safety block
- Fingerprint proof stainless steel

Cooking Functions & Features: 6



\$850

Usual Price \$950

Hobs Advantage

Teka Hobs are reshaping the kitchen landscape by seamlessly blending ease and innovation, perfectly suited to the heart of Asian cooking. As multi-award winners, including the People's Choice Best Hob, our hobs have earned acclaim from both home and professional chefs for their superior quality, performance, and style.

Curated for the discerning epicurean in Singapore, our diverse range features everything from smart induction to robust gas stoves, each underscoring our commitment to your effortless home cooking experience. Let Teka hobs be the cornerstone of your culinary adventures, your most trusted partner in the kitchen.

Highlights



Smart Power Management Curated for Singapore Kitchen

Teka's induction hobs are equipped with smart power management, ensuring adherence to predefined electrical limits. This feature prevents kitchen circuit overloads and protects against power trips, perfect for the unique electrical setups of HDB and condominium residences.



Blue Flame Technology Fuel gas cooking with efficiency

Teka gas hobs go beyond cooking firepower; it's a journey of efficiency. Our gas hobs produce blue flames—the mark of complete combustion. This maximises heat while minimising waste, achieving the balance of more for less.

Full Suite of Safety Features Safety first, Teka's promise

We prioritise safety in all our hobs – be it induction, vitroceramic, or gas. Our hobs come equipped with child locks, residual heat indicators, and auto-lock gas disconnections. This suite of safety features allows you to cook with total confidence and peace of mind.



Imagine a future where technology intuitively understands your cooking needs and adapts to every recipe with constant precision.

That future is now.

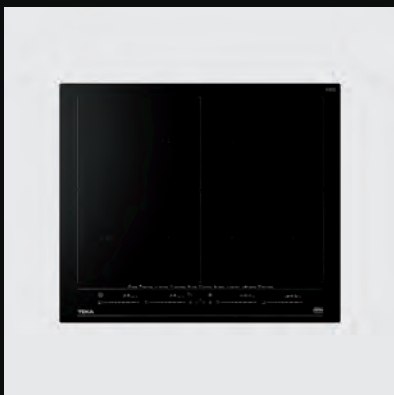

IZF 68700 MST

60cm Induction Hob

Dimensions: W x H x D (mm)

600 x 510 x 50

Product Highlights:

4 cooking zones (mm):
4 Flexi (262.5 x 195)

DirectSense precision cooking with temperature sensors

Cooking timer & child lock

Scratch resistant ceramic glass



Product of the Year Award

People's choice category

DirectSense Precision Cooking: 10

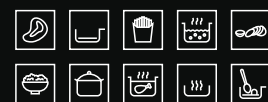

\$2,590

Usual Price \$3,800

DirectSense Precision Cooking

10 specialised cooking functions for all your recipes

Step into the future of home cooking with Teka's DirectSense technology. Simply select your desired dish and let your hob do the cooking. Equipped with intelligent sensors that detect your cookware's temperature, it automatically adjusts to the ideal cooking level, ensuring consistently amazing results every time.



Video

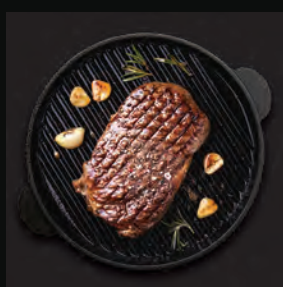

 **Grilling**
200°C

Achieve the perfect sear on meats and vegetables with high heat.



 **Pan Frying**
190°C

Ideal for everything from tender salmon to golden pancakes.



 **Deep Frying**
180°C

Accurate temperature control for safer, crisper frying.



 **Quick Boiling**
100°C

Rapidly boil 1 litre of water, making pasta preparation swift.



 **Poaching**
100°C

Gently cook ingredients for soft, flavourful outcomes.

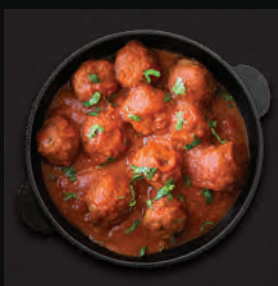

 **Simmering**
98°C

Ideal for slow-cooking soups and stews just below boiling point.



 **Confit**
80°C

Slowly cook ingredients for deep, rich flavours in jams and sauces.



 **Keep Warm**
60°C

Maintain your dishes at the right serving temperature.



 **Rice Cooking**
100°C

The first induction hob that cooks rice perfectly, managing temperature, water, and time.



 **Melting**
48°C

Melt butter or chocolate gently, avoiding over cooking and burning.



IZC 63630 MST White 3 zones
60cm Induction Hob

Dimensions: W x H x D (mm)
600 x 510 x 53 15-30 Amp

Product Highlights:

- 3 cooking zones (mm):
Ø 320/180, Ø 215, Ø 150
- DirectSense precision cooking with sensors
- Cooking timer & child lock
- Scratch resistant ceramic glass

DirectSense Precision Cooking: 8



\$2,290 Usual Price \$3,300



IZS 34700 MST 2 zones
30cm Modular Induction Hob

Dimensions: W x H x D (mm)
300 x 510 x 53 15 Amp

Product Highlights:

- 2 cooking zones (mm):
2 Flexi (255 x 200)
- DirectSense precision cooking with sensors
- Intuitive Multislider & Slidecooking
- Cooking timer & child lock
- Scratch resistant ceramic glass

DirectSense Precision Cooking: 7



\$1,390 Usual Price \$1,650



IZF 94300 MSP 4 zones
90cm Induction Hob

Dimensions: W x H x D (mm)
900 x 510 x 53 15-30 Amp

Product Highlights:

- 4 cooking zones (mm):
1 (Ø 280), 2 (235 x 188.5), 1 (Ø 185)
- DirectSense precision cooking with sensors
- Multislider & Flex touch control
- Cooking timer & child lock
- Scratch resistant ceramic glass

DirectSense Precision Cooking: 3



\$2,990 Usual Price \$3,300



IZF 65320 MSP 3 zones
60cm Induction Hob

Dimensions: W x H x D (mm)
600 x 510 x 50 15-30 Amp

Product Highlights:

- 3 cooking zones (mm):
Ø 150/280, 2 Ø 230 x 188
- DirectSense precision cooking
- MultiSlider touch control & FlexiZone
- Scratch resistant ceramic glass

3 zones

15-30 Amp

DirectSense Precision Cooking: 3



\$2,090 Usual Price \$2,900



IBC 7322 S 2 zones
73cm Induction Hob

Dimensions: W x H x D (mm)
730 x 430 x 60 20 Amp

Product Highlights:

- 2 cooking zones (mm): 2 Ø 200
- MultiSlider touch control
- Power Plus function
- Cooking timer & child lock
- Scratch resistant ceramic glass

2 zones

20 Amp

\$1,490 Usual Price \$1,790

Teka VitroCeramic Hobs

All-cookware compatibility for modern cooking

A Teka Vitroceramic hob is the embodiment of versatility and efficiency in modern home cooking. It provides flameless cooking over a smooth ceramic glass surface, ensuring power without compromising on style and safety, not to mention the ease of cleaning. But the true convenience of a Teka vitroceramic hob lies in its all-cookware compatibility, ideal for those transitioning from traditional gas stoves.



TZ 6315

60cm VitroCeramic Hob

Dimensions: W x H x D (mm)

600 x 510 x 53

Product Highlights:

3 cooking zones (mm):
 Ø 210/270, Ø 210, Ø 145

Residual heat indicator & child lock
 9 power levels, boost & cooking timer
 Scratch resistant ceramic glass

3
zones

23
Amp

\$1,090

Usual Price \$1,550



TZC 32320 TTC

30cm Modular VitroCeramic Hob

Dimensions: W x H x D (mm)

300 x 510 x 58

Product Highlights:

2 cooking zones (mm):
 Ø 210, Ø 145

Residual heat indicator
 9 power levels & cooking timer
 Scratch resistant ceramic glass

2
zones

13
Amp

\$850

Usual Price \$1,050

Teka ExactFlame Gas Hobs

Welcome to the new age of traditional flame cooking

If you love the timeless art of open-flame cooking, get ready to be amazed by Teka's ExactFlame precision technology. This innovation pushes the boundaries of flame cooking, providing accurate control over the intensity of the flame. Whether you need a low simmer at level 1 or a powerful boil at 9, ExactFlame delivers the perfect heat every time.

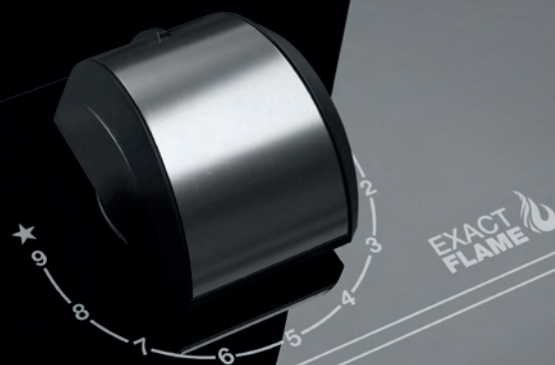

GZC 63310

60cm Gas On Glass Hob



Dimensions: W x H x D (mm)

600 x 510 x 50



Product Highlights:

ExactFlame: Precise flame intensity control from 1 - 9

3 cooking zones:

- Double ring burner (4kW)
- Fast burner (2.8 kW)
- Auxiliary burner (1kW)

Auto-ignition (Electrical - 13 Amp)

Auto-lock gas disconnection

Cast iron grids with ergonomic frontal control knobs

Scratch resistant ceramic glass

\$1,190

Usual Price \$1,600

GZC 32300

30cm Gas On Glass Hob



Dimensions: W x H x D (mm)

300 x 510 x 50



Product Highlights:

ExactFlame: Precise flame intensity control from 1 - 9

2 cooking zones:

- Fast burner (2.8kW)
- Auxiliary burner (1kW)

Auto-ignition (Electrical - 13 Amp)

Safety features: Auto-lock gas disconnection

Cast iron grids with ergonomic frontal control knobs

Scratch resistant ceramic glass

\$1060

Usual Price \$1,300

GZC 31330

30cm Gas On Glass Hob



Dimensions: W x H x D (mm)

300 x 510 x 50



Product Highlights:

ExactFlame: Precise flame intensity control from 1 - 9

1 cooking zones:

- Double ring burner (4kW)

Auto-ignition (Electrical - 13 Amp)

Safety features: Auto-lock gas disconnection

Cast iron grids with ergonomic frontal control knobs

Scratch resistant ceramic glass

\$1,150

Usual Price \$1,400



GK LUX 86.1 3G

86cm Gas On Glass Hob



Dimensions: W x H x D (mm)

860 x 480 x 65

Product Highlights:

3 cooking zones:
 2 Triple-ring wok burners (3.5kW)
 Triple-ring semi-fast burner (1.2kW)

Auto-ignition (Battery)

Auto-lock gas disconnection

Individual cast iron grids

Frameless tempered glass

\$930

Usual Price \$1,200



GK LUX 78.1 3G

78cm Gas On Glass Hob



Dimensions: W x H x D (mm)

780 x 460 x 65

Product Highlights:

3 cooking zones:
 2 Triple-ring wok burners (3.5kW)
 Triple-ring semi-fast burner (1.2kW)

Auto-ignition (Battery)

Auto-lock gas disconnection

Individual cast iron grids

Frameless tempered glass

\$850

Usual Price \$1,100



EX 90.1 3G

90cm gas Hob



Dimensions: W x H x D (mm)

860 x 500 x 84

Product Highlights:

3 cooking zones:
 2 Double ring burners (4kW)
 Fast burner (2.8kW)
 Auxiliary burner (1.75kW)

High-efficiency burners

Stainless steel finishing

Auto-ignition (Electrical - 13 Amp)

Auto-lock gas disconnection

Cast iron grids

\$1,100

Usual Price \$1,500



EX 70.1 3G

70cm gas Hob



Dimensions: W x H x D (mm)

680 x 500 x 84

Product Highlights:

3 cooking zones:
 2 Double ring burners (4kW)
 Fast burner (2.8kW)
 Auxiliary burner (1.75kW)

High-efficiency burners

Stainless steel finishing

Auto-ignition (Electrical - 13 Amp)

Auto-lock gas disconnection

Cast iron grids

\$1,000

Usual Price \$1,400

Hoods Advantage

Cooker hoods are often the unsung heroes of the kitchen. While the hob takes center stage in cooking, the hood plays an important complementary role, discreetly eliminating smoke and odours to keep your kitchen a welcoming space. Teka hoods are crafted to effortlessly maintain this balance, and more. With their sleek design and efficient performance, they're not just appliances; they're integral to your kitchen's harmony.

Explore Teka's varied range of hoods, masterfully crafted to ensure that every kitchen finds its perfect match.

Highlights

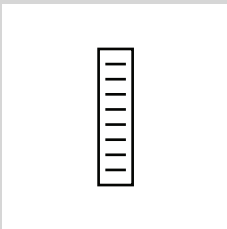

Downdraft Cooker Hood

Teka's Downdraft Cooker Hoods provide innovative, countertop ventilation for a sleek kitchen look.

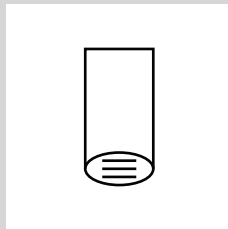

Island Cooker Hood

Perfect for kitchen islands, Teka's Island Cooker Hoods offer efficient ventilation with an elegant touch.

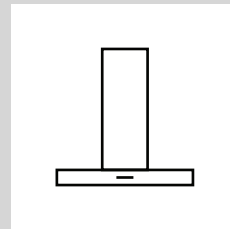

Chimney Cooker Hood

Stylish and functional, Teka's Chimney Cooker Hoods ensure a fresh and ventilated cooking environment.

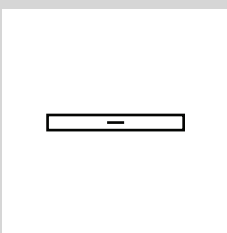

Slimline Cooker Hood

Sleek and space-efficient, Teka's Slimline Cooker Hoods blend modern design with optimal functionality.

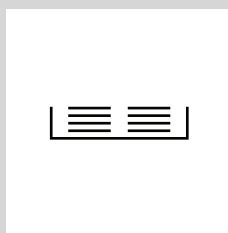

Built-in Hood

Teka's Built-in Hoods combine discreet design with effective smoke and odour removal, maintaining kitchen elegance.

Note: The maximum exhaust capacity of Teka hoods is the theoretical exhaust power a motor could generate if it is subjected to its maximum output or performance.



FIH 16760 TOS

Modular Downdraft Hood

Dimensions: W x H x D (mm)
110 x 186 x 510

Product Highlights:
FreshAir function
3 speeds + intensive
EcoPower brushless motor
Bevelled front glass
Optional: RFH 36100 FOA kit



600
m²/h



62
dB



DDI 90

Downdraft Hood

Dimensions: W x H x D (mm)
880 x 718 x 115

Product Highlights:
4 speeds
Touch control panel
Stop delay timer
LED lamps: 2
Optional: RFH 36100 FOA kit



1000
m²/h



RFH 36100 FOA

Regenerative Recirculation Kit

Product Highlights:

Compatible with FIH 16760 TOS & DDI 90
Recommended recirculation kit when venting to the outside is not possible
Regenerative active carbon filters help maintain a clean and healthy kitchen environment
Filters are easy to install and replace

\$4,900

\$3,390 Usual Price \$3,990

\$400



CC 485

40cm Tubular Island Hood

Dimensions: W x H x D (mm)
400 x 815 - 1115 x 400

Product Highlights:
3 speeds + intensive
EcoPower motor
Energy: A class
Stop delay timer
Stainless steel filters: 2
LED lamps: 2



1200
m²/h



50
dB



DPL ISLA 1185

110cm Island Hood

Dimensions: W x H x D (mm)
1100 x 600 - 1000 x 605

Product Highlights:
3 speeds + intensive
EcoPower motor
Energy: A class
Stop delay timer
Aluminium filters: 3
LED lamps: 4



1200
m²/h



54
dB



DH2 ISLA 985

90cm Island Hood

Dimensions: W x H x D (mm)
900 x 879 - 1179 x 600

Product Highlights:
3 speeds + intensive
EcoPower motor
Electronic control with display
Stop delay timer
Stainless steel filters: 2
LED lamps: 4



1200
m²/h



52
dB

\$2,890 Usual Price \$3,600

\$3,690 Usual Price \$3,800

\$2,390 Usual Price \$2,900



Limited Edition

DVT 98660 TBS White

90cm Vertical Chimney Hood 

Dimensions: W x H x D (mm)

900 x 800 - 1100 x 412

 **1200**
m²/h

Product Highlights:

- 3 speeds + intensive
- Touch control with display
- FreshAir function
- Stop delay timer
- Aluminium filter: 2
- LED lamps: 2

 **(52)**
dB

\$2,290

Usual Price \$2,900



Limited Edition

DVN 77050 TTC White

70cm Vertical Chimney Hood 

Dimensions: W x H x D (mm)

698 x 690 - 1035 x 325

 **1200**
m²/h

Product Highlights:

- 3 speeds + intensive
- Sound (dB): Max 64
- Touch control with digital display
- Rim extraction
- Stop delay timer
- Aluminium filter: 1
- LED lamps: 2

 **(54)**
dB

\$1,550

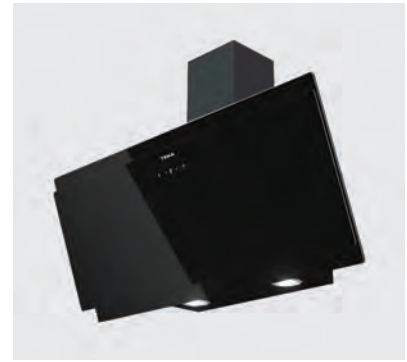

DVS 90 AD

90cm Chimney Hood 

Dimensions: W x H x D (mm)

895 x 770 - 1120 x 380

 **1500**
m²/h

Product Highlights:

- 3 speeds
- Powerful motor: Kraftvoll technology
- Rim extraction
- Digital display
- Stop delay timer
- Metal filters (ducting system)
- LED lamps: 2

 **(65)**
dB

\$1,390

Usual Price \$1,750



DLH 1185 T

110cm Chimney Hood 

Dimensions: W x H x D (mm)

1100 x 625 - 955 x 480

 **1200**
m²/h

Product Highlights:

- 3 speeds + intensive
- EcoPower motor
- 4 A Class efficiencies
- Stop delay timer
- Stainless steel filters: 3 (12 layers)
- LED bar: 1

 **(54)**
dB

\$1,950

Usual Price \$2,200



DGW 97350 / 67350

90cm/60cm Chimney Hood 

Dimensions: W x H x D (mm)

900/600 x 625 - 955 x 500

 **1200**
m²/h

Product Highlights:

- 4 speeds
- Energy: A class
- Stop delay timer
- Stainless steel filter
- LED lamps: 2

 **(68)**
dB

\$790

DGW 97350
Usual Price \$1,050

\$690

DGW 67350
Usual Price \$950



DSI 90 AD Black

90cm Chimney Hood 

Dimensions: W x H x D (mm)

900 x 488 - 968 x 500

 **1500**
m²/h

Product Highlights:

- 3 speeds
- Powerful motor: Kraftvoll technology
- Reinforced black glass panel
- Touch-free control with digital display
- Aluminium filters: 3
- LED bar: 1

 **(65)**
dB

\$1,390

Usual Price \$1,750



CNL 6415 Plus

60cm Slimline Pull Out Hood

Dimensions: W x H x D (mm)

600 x 184 x 300 - 490

Product Highlights:

- 5 + 1 speeds
- EcoPower Motor
- Exchangeable front panel
- Automatic lighting
- Stainless steel filters: 2 (MMX)
- LED bar: 1



730
m³/h

(52)
dB



TL 9310

90cm Slimline Pull Out Hood

Dimensions: W x H x D (mm)

900 x 181 x 304 - 437

Product Highlights:

- 2 speeds
- Mechanical control
- Exchangeable front panel
- Automatic switch on/off
- Aluminium filters: 4
- LED lamps: 2



440
m³/h

(45)
dB



TL 6310

60cm Slimline Pull Out Hood

Dimensions: W x H x D (mm)

600 x 181 x 304 - 437

Product Highlights:

- 2 speeds
- Mechanical control
- Exchangeable front panel
- Automatic switch on/off
- Aluminium filters: 2
- LED lamps: 2



440
m³/h

(45)
dB

\$690

Usual Price \$750

\$680

Usual Price \$750

\$480

Usual Price \$550



TLR2 92 BK

90cm Slimline Pull Out Hood

Dimensions: W x H x D (mm)

895 x 161 x 297 - 463

Product Highlights:

- 2 speeds
- Mechanical control
- Exhaust ventilation on front
- Automatic lighting
- Aluminium filters: 3
- Incandescent lamps: 2



540
m³/h



TLR2 92 SS

90cm Slimline Pull Out Hood

Dimensions: W x H x D (mm)

895 x 161 x 297 - 463

Product Highlights:

- 2 speeds
- Mechanical control
- Exhaust ventilation on front
- Automatic lighting
- Aluminium filters: 3
- Incandescent lamps: 2



540
m³/h



TLR2 62 SS

60cm Slimline Pull Out Hood

Dimensions: W x H x D (mm)

595 x 161 x 297 - 463

Product Highlights:

- 2 speeds
- Mechanical control
- Exhaust ventilation on front
- Automatic lighting
- Aluminium filters: 2
- Incandescent lamps: 2



540
m³/h

\$680

Usual Price \$800

\$680

Usual Price \$800

\$520

Usual Price \$700

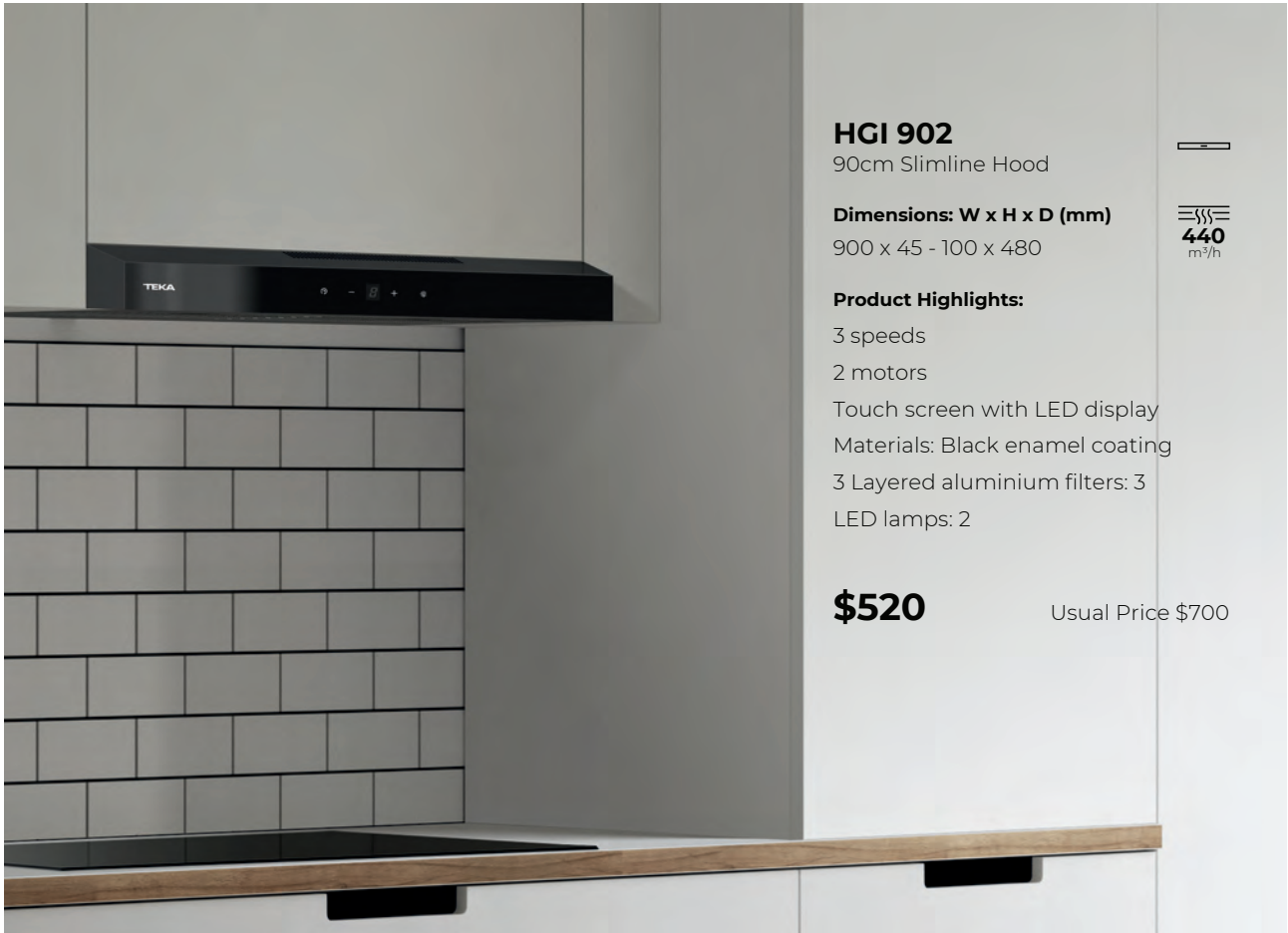

HGI 902
90cm Slimline Hood

Dimensions: W x H x D (mm)
900 x 45 - 100 x 480

440
m³/h

- Product Highlights:**
- 3 speeds
 - 2 motors
 - Touch screen with LED display
 - Materials: Black enamel coating
 - 3 Layered aluminium filters: 3
 - LED lamps: 2

\$520 Usual Price \$700



GFX 72
70cm Built-in Hood

Dimensions (mm):
W 725
H 276
D 291



750
m³/h

- Product Highlights:**
- 3 speeds
 - Dual motor
 - Push-button control panel
 - Metal filter
 - Work indicator light
 - LED lamps: 2

\$550 Usual Price \$650

Integrated Hoods & Hobs Advantage

Reimagine your cooking space with Teka! Winner of the People's Choice and Product of the Year 2023 awards, our MasterSense Air integrated hood and hob series epitomises all-in-one versatility, performance, and design.

Strategically integrated between both induction hobs, our downdraft hood preserves the symmetry and aesthetic of your kitchen while optimising space. This ingenious design seamlessly eliminates vapours and odours, maintaining a refined atmosphere even during the busiest cooking sessions.

Join the world of Teka, where every detail is designed with the art of simplicity and functionality in mind.



MasterSense Air AFF 87601 MST 80cm Integrated Hood and Hob

Dimensions: W x H x D (mm)
800 x 510 x 219

6
zones

627
m²/h

15-30
Amp

Induction Hob Highlights:

- 6 cooking zones (mm): 4 x Ø 250, 2 x FullFlex
- DirectSense precision cooking with sensors
- Cooking timer
- Child & Auto-lock safety system
- Scratch resistant ceramic glass

Downdraft Hood Highlights:

- Automatic hood activation
- FreshAir function
- 9 speeds + intense
- EcoPower brushless motor
- Stop delay timer
- Sound (dB): Min 43 / Max 65
- 12-layered aluminium filters: 2
- Filter saturation indicator

DirectSense Precision Cooking: 8



\$7,900



Semi-Integrated Hood & Hob



EUROPEAN
PRODUCT
DESIGN
AWARD

Discover the multi-award-winning Teka VarioPro series, a modular kitchen innovation that adapts to your unique style and culinary requirements. Customise your cooking space by seamlessly mixing and matching different hobs with the downdraft hood, unlocking a world of endless possibilities.

GOOD
DESIGN

Offering a range of options from induction to VitroCeramic and gas hobs, the VarioPro series empowers you to redefine your kitchen according to your exact preferences. Ideal for passionate home cooks, professional chefs, or those seeking a perfect blend of style and functionality, Teka's VarioPro series is the perfect solution for all your kitchen needs.





VarioPro Kitchen Series

Model Page

GZC 32300
30cm Modular Gas On Glass Hob 29



IZS 34700 MST
30cm Modular Induction Hob 27



FIH 16760 TOS
Modular Downdraft Hood 32



GZC 31330
30cm Modular Gas On Glass Hob 29

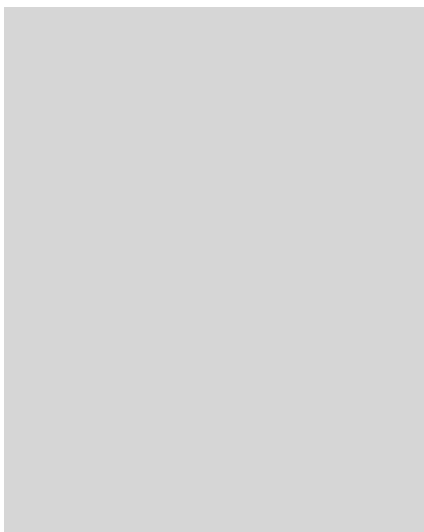

TZC 32320 TTC
30cm Modular VitroCeramic Hob 28



Dishwashers Advantage

Cooking can be a joy, but the cleanup afterwards? Not so much. At Teka, we get it. That's why we've crafted our dishwashers to seamlessly take over the post-meal chores, giving you back precious time for the things that truly matter.

But there's more to our dishwashers than just saving time. Contrary to these common misconceptions:

Highlights

Uses more water than hand washing

A University of Bonn study reveals hand washing uses 8 times more water than dishwashers. Teka's dishwashers efficiently clean up to 150 items in a single load.

Doesn't clean dishes effectively

Teka Dishwashers combine high-pressure hot water with negative ions for thorough cleaning, eliminating bacteria and odours at a molecular level.

Too expensive

Despite a higher initial cost, Teka Dishwashers are energy-efficient, reducing long-term expenses on energy bills.





Cabinetry door / panel not provided

DFI 76950

Fully Integrated Dishwasher

Dimensions: W x H x D (mm)

598 x 818 - 868 x 550

Product Highlights:

Washing temperatures (°C): 35, 40, 45, 50, 65, 70

Fast program: 30 minutes

MultiFlex 3 cutlery trays for maximum space and flexibility

Automatic door opening at the end of a washing cycle



Installation:

Built-in / fully integrated

Special functions: Half-load, Express, PowerWash, PremiumDry & IonClean

IonClean technology use negative ions to eliminate bacteria and odours

SmartSensor automatically adjust the wash cycle settings based on the level of dirt

Washing Programs: 9



\$2,490

Usual Price \$3,500



Cabinetry door / panel not provided

DSI 46750

Partially Integrated Dishwasher

Dimensions: W x H x D (mm)

598 x 815 - 865 x 570

Product Highlights:

Washing temperatures (°C): 45, 50, 55, 65, 70

Special functions: Half-load, Express, PowerWash & ExtraDry



Installation:

Built-in / fully integrated

Fast program: 30 minutes

SmartSensor automatically adjust the wash cycle settings based on the level of dirt

Washing Programs: 7



\$1,990

Usual Price \$2,700

Dishwasher Program Symbols and Functions



DualCare

Adjusts water pressure based on tray contents



GlassCare

Thoroughly cleans and protects delicate glasswares



AutoClean

Self-cleaning program to keep dishwasher flawless



AutoProgram

Detects and adjust washing settings based on dirt level



Intensive Program

Intense washing setting to effectively remove tough stains



Eco Program

A washing cycle option that uses lesser water and energy



1-Hour

Wash and dry dishes in one hour



30-Minutes

Express washing cycle to clean dishes quickly



Whisper

Exceptionally quiet operation for discreet cleaning



PreWash

Pre-wash particle removal for enhanced cleaning efficiency

Refrigerators Advantage

Teka integrated refrigerators offer an ideal combination of cost-effectiveness, ease of installation, and compatibility. Designed for effortless integration into any kitchen layout, these refrigerators are the perfect choice for upgrades or replacements, compatible with most brands of integrated refrigerators. They enhance not only your kitchen's functionality and space utilisation but also add a touch of modern flair to your space.

RVU 20046 GBK

Built-in Wine Chiller

Dimensions (mm):

W 595

H 805 - 820

D 574 (Handle +45)



Product Highlights:

Dual temperature control

Inner control display

Electronic adjustable thermostat

PerfecTemp: store different wines at optimal temperatures in one location

\$2,990

Wine preservation: humidity control & carbon air filter

LED illumination

Installation: Reversible doors

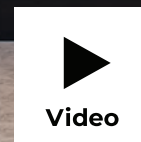

TF13 130 D EU

85cm Fully Integrated Bar Refrigerator



125 litres



Dimensions: W x H x D (mm)

545 x 820 - 870 x 545

Product Highlights:

Manual adjustable thermostat

Automatic defrost

Inner freezer included

2 safety glass shelves

LED illumination

Installation:

Built-in / fully integrated

Reversible doors

\$1,950



RBF 330 FI MY

Fully Integrated No-Frost Refrigerator



241 litres



Dimensions: W x H x D (mm)

540 x 1775 - 1785 x 645

Product Highlights:

No-frost built-in refrigerator

Fresh box drawer keeps food fresh for longer by maintaining a lower temperature

Easy touch for temperature control

Installation:

Built-in / fully integrated

Reversible doors

\$3,100

Kitchen Sinks Advantage

From our roots in stainless steel manufacturing, Teka has evolved over a century, mastering the art of moulding the finest kitchen sinks for homes worldwide. With a deep understanding and meticulous design, we present an extensive range of sinks designed to perfectly complement your kitchen. Choosing a Teka sink means more than just acquiring a new kitchen cornerstone; it's inheriting a legacy of craftsmanship. Discover the pinnacle of quality that has stood the test of time.

Highlights

Teka kitchen sinks are available in two distinctive materials:



18/10 Austenitic Stainless Steel

Composition:
Fe + C + Cr + Ni

Teka's sinks are meticulously crafted from the highest quality austenitic stainless steel, ensuring superior durability and resistance to shocks, corrosion, and staining. The high nickel content of this steel guarantees a hygienic surface that's easy to maintain, keeping your sink pristine for years

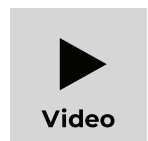

Teganite+

Composition:
SiO₂ + pHEMA + Ag⁺

Teka's Teganite+ material is specifically designed to meet the rigorous demands of daily kitchen use. Our exclusive signature blend is impressively resistant to impacts, dirt, and temperature changes, ensuring effortless cleanliness with antimicrobial protection.

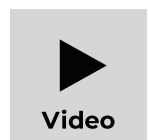



Intro 82

Top Mount Single Bowl
Stainless Steel Kitchen Sink

External: W x H (mm)
820 x 500

Bowl: W x H x D (mm)
770 x 400 x 200 (Ø 15)

Product Highlights:

Base unit (mm): 900
Deep bowl (mm): 200
Durable austenitic stainless steel
SilentSmart noise-cancelling

\$730

Usual Price \$890



Intro 60

Top Mount Single Bowl
Stainless Steel Kitchen Sink

External: W x H (mm)
600 x 500

Bowl: W x H x D (mm)
550 x 400 x 200 (Ø 15)

Product Highlights:

Base unit (mm): 700
Deep bowl (mm): 200
Durable austenitic stainless steel
SilentSmart noise-cancelling

\$660

Usual Price \$780



Linea 200.400

Undermount Single Bowl
Stainless Steel Kitchen Sink

External: W x H (mm)
240 x 440

Bowl: W x H x D (mm)
200 x 400 x 48 (Ø 1)

Product Highlights:

Base unit (mm): 400
Durable austenitic stainless steel
SilentSmart noise-cancelling

\$380

Usual Price \$470



Stone 90 B-TG 2B

Top Mount Double Bowl
Tegrinite+ Kitchen Sink

External: W x H (mm)
860 x 510

Bowl: W x H x D (mm)
347 x 414 x 200

Product Highlights:

Base unit (mm): 900
Tegrinite+ quartz
High resistant to impacts, dirt and temperature changes
Easy to clean bacteria-free surface
Pop-up waste included

\$1,020

Usual Price \$1,320



Square 72.40 TG

Undermount Single Bowl
Tegrinite+ Kitchen Sink

External: W x H (mm)
760 x 440

Bowl: W x H x D (mm)
720 x 400 x 200

Product Highlights:

Base unit (mm): 800
Deep bowl (mm): 200
Tegrinite+ quartz
High resistant to impacts, dirt and temperature changes
Easy to clean bacteria-free surface

\$1,020

Usual Price \$1,200



Square 50.40 TG

Undermount Single Bowl
Tegrinite+ Kitchen Sink

External: W x H (mm)
540 x 440

Bowl: W x H x D (mm)
500 x 400 x 200

Product Highlights:

Base unit (mm): 600
Deep bowl (mm): 200
Tegrinite+ quartz
High resistant to impacts, dirt and temperature changes
Easy to clean bacteria-free surface

\$840

Usual Price \$1,050



FlexLinea RS15 71.40

3-in-1 Mount Single Bowl
Stainless Steel Kitchen Mixer

External: W x H (mm)
750 x 440

Bowl: W x H x D (mm)
710 x 400 x 200 (Ø 15)

Product Highlights:

Base unit (mm): 800
Deep bowl (mm): 200
Durable austenitic stainless steel
SilentSmart noise-cancelling

\$920

Usual Price \$1,420



FlexLinea RS15 50.40

3-in-1 Mount Single Bowl
Stainless Steel Kitchen Sink

External: W x H (mm)
540 x 440

Bowl: W x H x D (mm)
500 x 400 x 200 (Ø 15)

Product Highlights:

Base unit (mm): 600
Deep bowl (mm): 200
Durable austenitic stainless steel
SilentSmart noise-cancelling

\$780

Usual Price \$1,200



ARQ 70.45

Undermount Single Bowl
Stainless Steel Kitchen Sink

External: W x H (mm)
700 x 450

Bowl: W x H x D (mm)
650 x 400 x 220 (Ø 15)

Product Highlights:

Base unit (mm): 800
Deep bowls (mm): 220
Durable austenitic stainless steel
SilentSmart noise-cancelling

\$690

Usual Price \$850



ARQ 2B 840

Undermount Double Bowl
Stainless Steel Kitchen Sink

External: W x H (mm)
840 x 430

Bowl: W x H x D (mm)
380 x 380 x 220 (Ø 15)

Product Highlights:

Base unit (mm): 900
Deep bowl (mm): 220
Durable austenitic stainless steel
SilentSmart noise-cancelling

\$850

Usual Price \$950



Square 340.400/180.400

Undermount Double Bowl
Stainless Steel Kitchen Sink

External: W x H (mm)
575 x 430

Bowl: W x H x D (mm)
340 x 400 x 180 (Ø 1)
180 x 400 x 180 (Ø 1)

Product Highlights:

Base unit (mm): 600
Durable austenitic stainless steel
SilentSmart noise-cancelling

\$620

Usual Price \$800



Linea 340.400/180.400

Undermount Double Bowl
Stainless Steel Kitchen Sink

External: W x H (mm)
592 x 440

Bowl: W x H x D (mm)
340 x 400 x 184 (Ø 1)
180 x 400 x 184 (Ø 1)

Product Highlights:

Base unit (mm): 600
Durable austenitic stainless steel
SilentSmart noise-cancelling
Accessories included: Pop-up waste

\$580

Usual Price \$700

Kitchen Mixers Advantage

Teka mixers are designed with a focus on thoughtfulness, blending ergonomic with style for a seamless addition to your kitchen. The high spout swivel, paired with superior handling sensitivity, ensures maximum comfort and control during use. Equipped with our proprietary ceramic cartridges, our taps deliver more than just aesthetic appeal. They efficiently conserve water and include built-in safety features to prevent scalding, ensuring each use is worry-free and sustainable.

Choose Teka mixers and enjoy the assurance of exceptional quality, safety, and convenience into your daily kitchen routine.

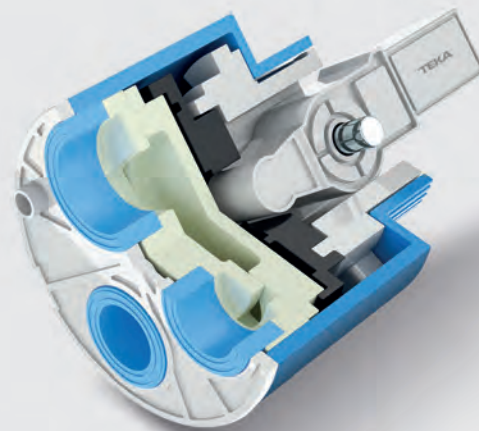

Highlights

Teka Ceramic Cartridges

- The integrated temperature limiter not only saves energy but also regulates water temperature, making every use energy-efficient.
- An adjustable flow gauge aids in water conservation and leakage prevention, reflecting our commitment to helping you save.
- The anti-scalding feature ensures a safe, user-friendly experience by capping the water temperature, thereby avoiding scalding.



FO 937 Black

Semi-Pro Flexible Spout Kitchen Mixer

Product Highlights:

High swivel spout:
more comfort space

High resistant flexible rubber tube

Pull-down shower: aerated spray

Stainless steel flexible hose

Great handling sensitivity

Highly precise temperature control

Anti-scalding

High resistance ceramic cartridge



\$650

Usual Price \$720



MB2 High Pull Out

Double Spray Pull-Out Kitchen Mixer

Product Highlights:

Chrome

High swivel spout:
more comfort space

Nylon pull-out hose

Double spray function

Great handling sensitivity

Highly precise temperature control

Anti-scalding

High resistance ceramic cartridge



\$550

Usual Price \$620



ARK 938

High Spout Pull-Out Kitchen Mixer

Product Highlights:

High swivel spout:
more comfort space

Extra resistant flexible hose

Great handling sensitivity

Highly precise temperature control

Anti-scalding

High resistance ceramic cartridge



\$520

Usual Price \$580



FO 915

High Spout Single Lever Kitchen Mixer

Product Highlights:

Minimalistic design

High swivel spout:
more comfort space

Great handling sensitivity

Highly precise temperature control

Anti-scalding

High resistance ceramic cartridge



\$580

Usual Price \$650



MB2

High Spout Single Lever Kitchen Mixer

Product Highlights:

High swivel spout:
more comfort space

Great handling sensitivity

Highly precise temperature control

Anti-scalding

High resistance ceramic cartridge



\$360

Usual Price \$450



IN 995

High Spout Single Lever Kitchen Mixer

Product Highlights:

Minimalistic design

High swivel spout:
more comfort space

Great handling sensitivity

Highly precise temperature control

Anti-scalding

High resistance ceramic cartridge



\$320

Usual Price \$360



Singapore

Contact

+65 6734 2415

hello@teka-sg.com

Support

+65 6235 2265

support@teka-sg.com

Website

www.teka-sg.com

Experience Centre

50 Kaki Bukit Place, #01-01

Singapore 415926

Follow Us

TekaSingapore



Download

Teka App



Available

www.lazada.sg/shop/teka-singapore

Welcome

The future of effortless

home cooking

Terms & Conditions

All promotions stated herein are valid until 31st Dec, 2024, and are only applicable to selected models, whilst stocks last. All items come with a 24-month warranty. Promotions are neither applicable nor linked to any other promotions or discounts that may be granted under ongoing or past marketing programs. All information presented here is correct at the time of printing but is subject to change. Cook With Love Pte. Ltd., the sole distributor of Teka kitchen appliances in Singapore, reserves the right to amend these terms and conditions without prior notice.

© Copyright 2024. Teka Singapore. Cook With Love Pte. Ltd. All Rights Reserved.